

SECTION 8

AIR CONDITIONING

Air conditioning

- [Automatic air conditioning controls](#)

300

Automatic air conditioning controls

Operations such as changing the air outlets or fan speed are carried out on the screen. To display the air conditioning control screen, push the “MENU” button and select “Climate”.

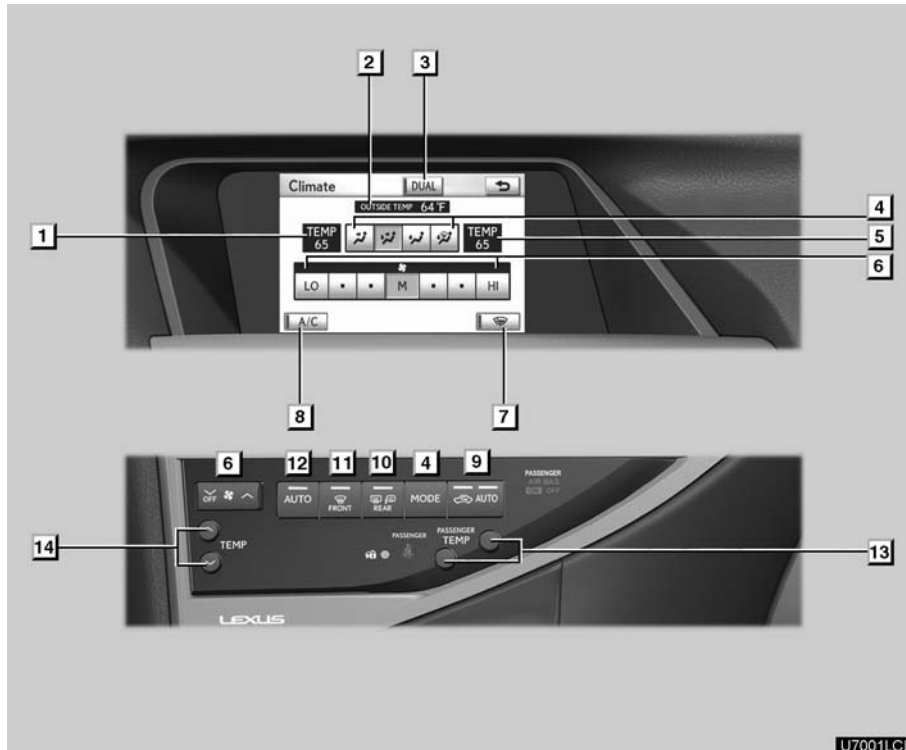

- | | |
|--|--|
| <p>1 Driver side temperature display
(In degrees Fahrenheit or Centi-
grade)</p> <p>2 Outside temperature display
(In degrees Fahrenheit or Centi-
grade) 310</p> <p>3 “DUAL”
(Temperature setting mode change
button) 303, 304</p> <p>4 Air flow control buttons 304</p> <p>5 Passenger side temperature dis-
play
(In degrees Fahrenheit or Centi-
grade)</p> | <p>6 Fan speed control buttons
. 304</p> <p>7 Windshield wiper de-icer button
. 308</p> <p>8 “A/C” 307</p> <p>9 Air intake control button
. 303, 306</p> <p>10 Rear window defogger button
. 309</p> <p>11 Windshield air flow button
. 306</p> <p>12 “AUTO” button 303</p> |
|--|--|

- 13 **“PASSENGER TEMP” buttons**
 (Passenger side temperature control button)
 (Only for the independent mode that display shows **“DUAL”**; mainly for front passenger and secondarily for driver) 303, 304

- 14 **“TEMP” buttons**
 (Driver side temperature control button) (At the independent mode that display shows **“DUAL”**; mainly for driver and secondarily for front passenger)
 (At the linked mode that display does not show **“DUAL”**; for driver) 303, 304

(a) Climate control

Air outlets and fan speed are automatically adjusted according to the temperature setting.

The **“ENGINE START STOP”** switch must be in **IGNITION ON** mode.



Push the **“MENU”** button and select **“Climate”** to display the air conditioning control screen.

INFORMATION

- *When the **“ENGINE START STOP”** switch is turn on, the air conditioning system settings will be set to those that were in use the last time the **“ENGINE START STOP”** switch was turned off. Air conditioning system settings are memorized individually on each electronic key, so the settings reproduced will be specific to the key that is used.*

- *During use, various odors from inside and outside the vehicle may enter into and accumulate in the air conditioning system. This may then cause odor to be emitted from the vents.*

AIR CONDITIONING

- *To reduce potential odors from occurring:*
 - *It is recommended that the air conditioning system be set to outside air mode prior to turning the vehicle off.*
 - *The start timing of the blower may be delayed for a short period of time immediately after the air conditioning system is started in automatic operation mode.*

NOTICE

To prevent the battery from being discharged, do not leave the air conditioning on longer than necessary when the engine is not running.



By pushing the switch above, you can operate the voice command system.

For the operation of the voice command system and the command, see pages 49 and 54.

(b) Using automatic air conditioning system

- **Switching to automatic operation mode**



Push the “AUTO” button.

The air conditioning system begins to operate. Air outlets and fan speed are automatically adjusted according to the temperature setting.

Push and hold “**OFF**” button to turn the air conditioning system off.

- **Setting the vehicle interior temperature**

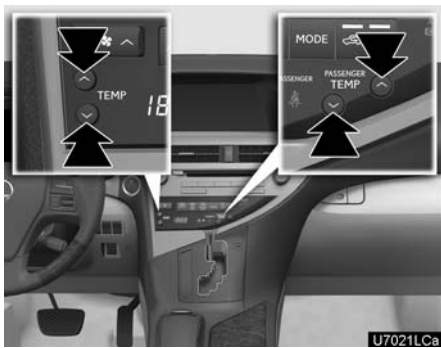

Push the “^” button on “TEMP” to increase the temperature and “v” to decrease the temperature.

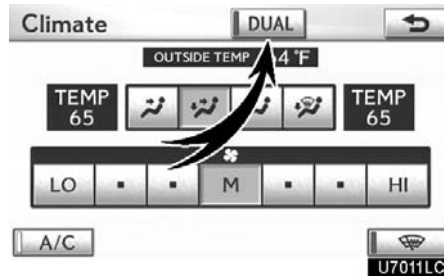

“**DUAL**” button is used to set the temperatures independently for the driver’s seat and front passenger seat.

When the “**DUAL**” indicator is on, the temperature for the driver’s seat and front passenger seat can be adjusted separately.

- **Switching the air intake control to automatic mode**



Push the air intake control button to switch to automatic mode.

The air conditioning system automatically switches between outside air and recirculated air modes.

INFORMATION

You can adjust the setting in automatic mode. (See page 411.)

AIR CONDITIONING

(c) Adjusting the settings manually

- Setting the fan speed

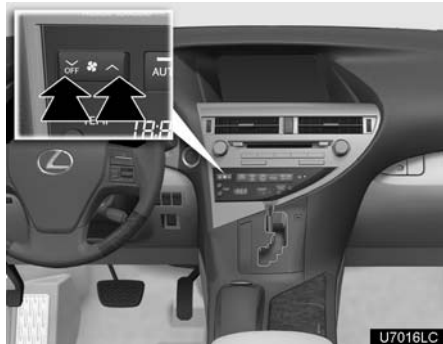

To turn on the air conditioning system and adjust the fan speed, push the “^” button on fan speed control button to increase the fan speed and push the “∇” button to decrease the fan speed.

To turn the fan off, push and hold the “∇ OFF” button.

Using the screen—

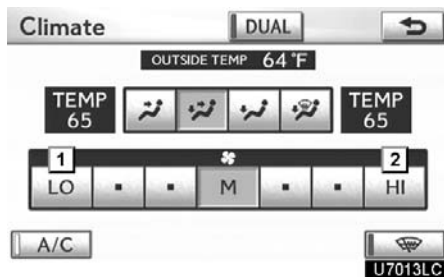

- 1 Fan speed at low
- 2 Fan speed at high

- Setting the vehicle interior temperature

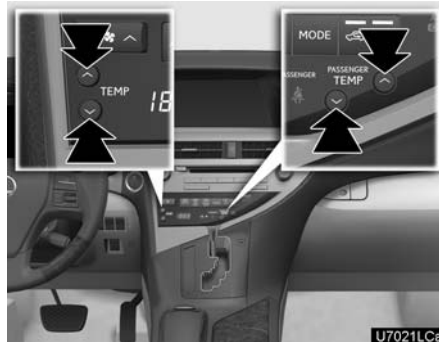

To adjust the temperature setting, push the “^” button on “TEMP” to increase the temperature and push the “∇” button to decrease the temperature.

When the “DUAL” indicator is on, the temperature for the driver’s seat and front passenger seat can be adjusted separately.

- Switching the air outlets



To change the air outlets, push the “MODE” button.

The air outlets used are switched each time the button is pushed.

Using the screen—

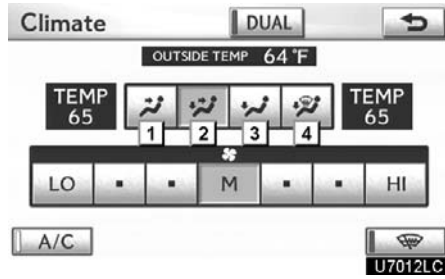

- 1 Panel
- 2 Bi-level
- 3 Floor
- 4 Floor/windshield

The air flow shown on the display indicates the following.

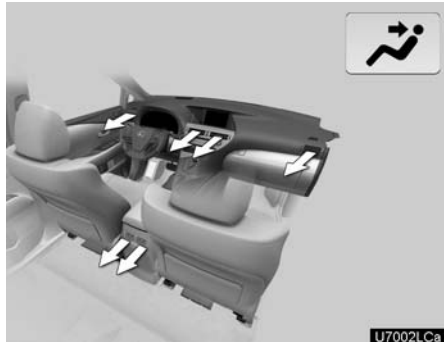

► Air flows to the upper body (Panel)

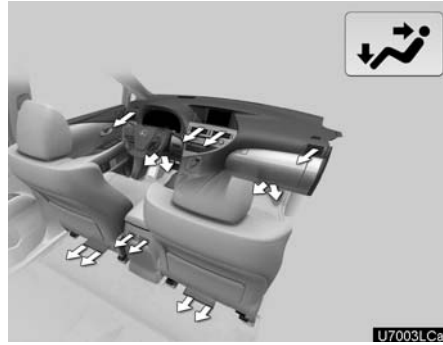

► Air flows to the upper body and feet (Bi-level)

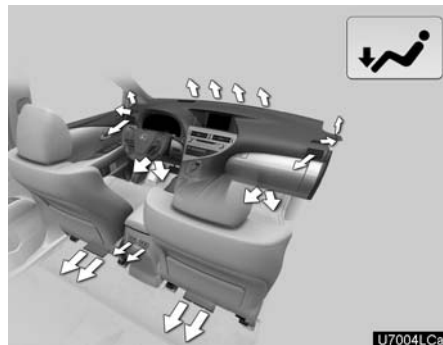

► Air flows to the feet (Floor)

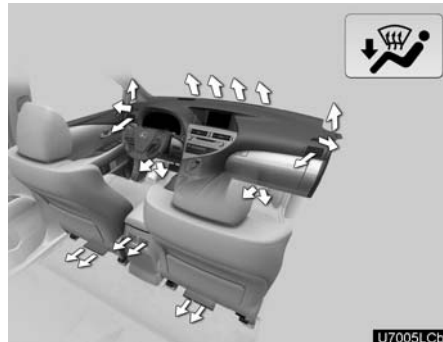

► Air flows to the feet and the windshield defogger operates (Floor/windshield)

AIR CONDITIONING

- Switching between outside air and recirculated air modes



Push the air intake control button.

The mode switches between outside air mode (the indicator is off), “**AUTO**” mode and recirculated air mode (the indicator is on) each time the button is pushed.

- (d) Defogging the windshield

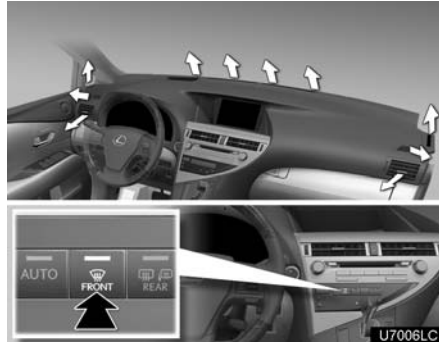

The air conditioning system operates automatically.

Recirculated air mode will automatically switch to outside air mode. It is not possible to return to recirculated air mode when the switch is on.

CAUTION

To prevent the windshield from fogging up

Do not use the windshield air flow button during cool air operation in extremely humid weather. The difference between the temperature of the outside air and that of the windshield can cause the outer surface of the windshield to fog up, blocking your vision.

(e) Adjusting the position of and opening and closing the air outlets

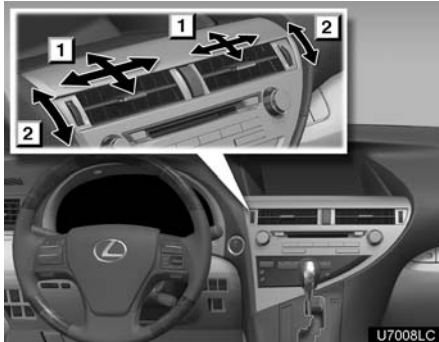

► Front center outlets

- 1 Direct air flow to the left or right, up or down
- 2 Turn the knob to open or close the vent

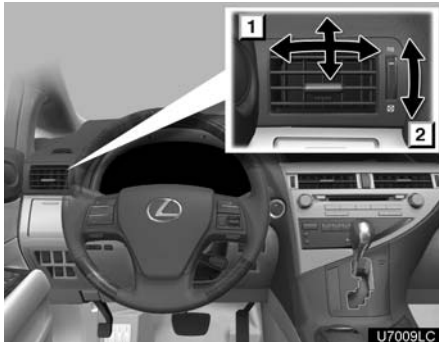

► Front side outlets

- 1 Direct air flow to the left or right, up or down
- 2 Turn the knob to open or close the vent

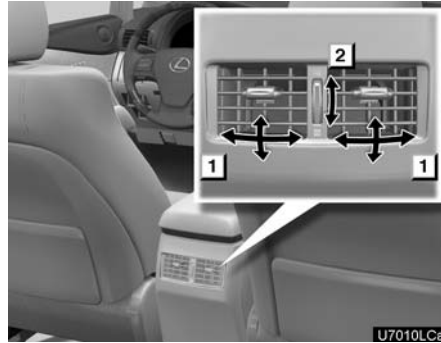

► Rear outlets

- 1 Direct air flow to the left or right, up or down
- 2 Turn the knob to open or close the vent

INFORMATION

- **Using automatic mode**
Fan speed is adjusted automatically according to the temperature setting and ambient conditions. As a result, the following may occur:
 - The system may switch automatically to recirculated air mode when the coolest temperature setting is selected in summer.
 - Immediately after the button is pushed, the fan may stop for a while until warm or cool air is ready to flow.
- **Using the system in recirculated air mode**
The windows will fog up more easily if recirculated air mode is used for an extended period.

- **Switching between outside air and recirculated air modes**

Recirculated air mode or outside air mode may be automatically switched to in accordance with the temperature setting and the inside temperature.

- **Window defogger feature**

Recirculated air mode may automatically switch to outside air mode in situations where the windows need to be defogged.

- **When outside air temperature is below 32°F (0°C)**

The cooling and dehumidification function may not operate even when "A/C" is on.

- **When the indicator light on "A/C" flashes**

Select "A/C" to turn off the cooling and dehumidification function and turn it on again. There may be a problem in the air conditioning system if the indicator light continues to flash. Turn the air conditioning system off and have it inspected by your Lexus dealer.

- **Automatic air intake change mode**

In automatic mode, the system automatically switches between recirculated air and outside air modes according to whether the system detects harmful substances such as exhaust gas in the air outside.

If you select automatic mode when only the fans are operating, the air conditioning system will turn on automatically.

(f) Windshield wiper de-icer (if equipped)

This feature is used to prevent ice from building up on the windshield and wiper blades.

The windshield wiper de-icer can be operated when the "ENGINE START STOP" switch is in IGNITION ON mode.

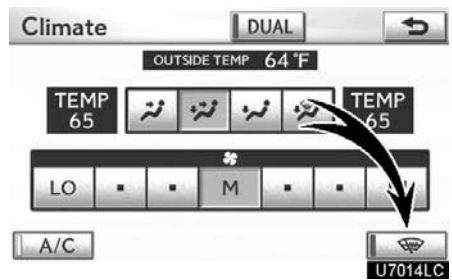

Turns the windshield wiper de-icer on/off.

The windshield wiper de-icer will automatically turn off after approximately 15 minutes.

⚠ CAUTION

When the windshield wiper de-icer is on

Do not touch the lower part of the windshield or the side of the front pillars, as the surfaces can become very hot and burn you.

(g) Rear window and outside rear view mirror defogging



To turn the electric rear window and outside rear view mirror defogger on, push the button above.

The "ENGINE START STOP" switch must be in IGNITION ON mode.

The thin heater wires on the inside of the rear window and the heater panels in the outside rear view mirrors will quickly clear the surface.

Keep your hands off the mirror faces when the system is on.

The indicator light is on when the defogger is operating.

The defoggers will automatically turn off after 15 to 60 minutes. The operation time changes according to the ambient temperature and vehicle speed.

If further defrosting or defogging is desired, simply actuate the switch again. When the surface has cleared, push the button once again to turn the defogger off. Continuous use may cause the battery to discharge, especially during stop-and-go driving. The defogger is not designed to dry rain water or to melt snow.

If the outside rear view mirrors are heavily coated with ice, use a spray de-icer before operating the system.

NOTICE

- ***When cleaning the inside of the rear window, be careful not to scratch or damage the heater wires or connectors.***
- ***To prevent the battery from being discharged, turn the switch off when the engine is not running.***

CAUTION

When the outside rear view mirror defoggers are on, do not touch the outside surface of the rear view mirror as it can become very hot and burn you.

AIR CONDITIONING

(h) Outside temperature display

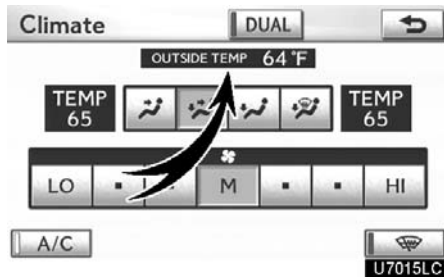

Outside temperature is displayed on the screen.

The displayed temperature ranges from -40°F (-40°C) up to 122°F (50°C).

If the temperature shows “- -” or “E”, take your vehicle to your Lexus dealer.

In the following situations, the correct outside temperature may not be displayed, or the display may take longer than normal to change.

- When stopped, or driving at low speeds (less than 15.5 mph [25 km/h])
- When the outside temperature has changed suddenly (at the entrance/exit of a garage, tunnel, etc.)

